

BEAM DRAWING
 THE MYSTERY OF THE OAK ISLAND TREASURE
 DIRECTOR - BOB PAISLY
 DESIGNER - ANDREW MURRAY / SI DAGINSTINE
 NOV. 11, 1984
 SCALE $\frac{1}{2}'' = 1'-0''$

FULL SCALE: HAND RAIL

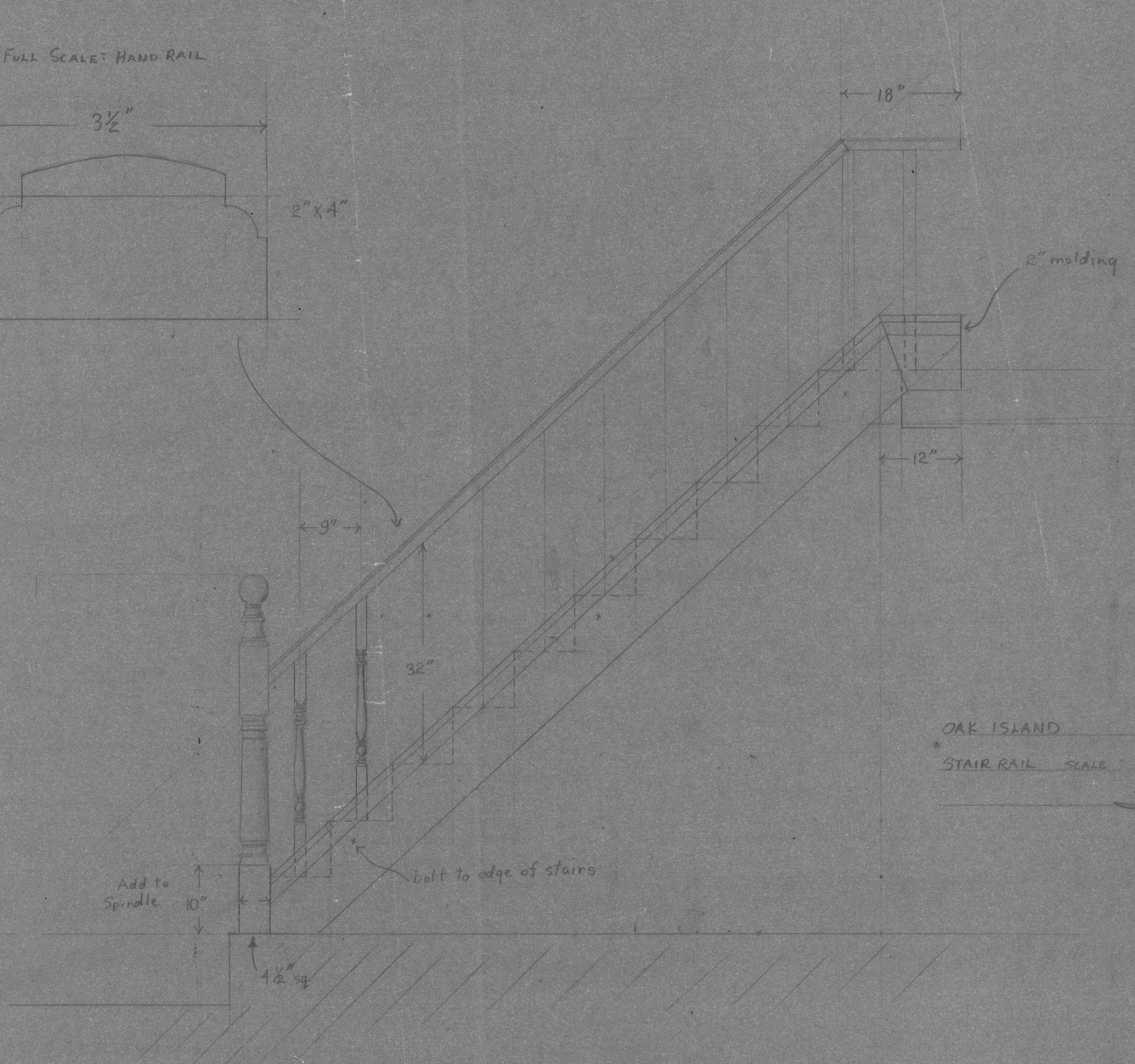
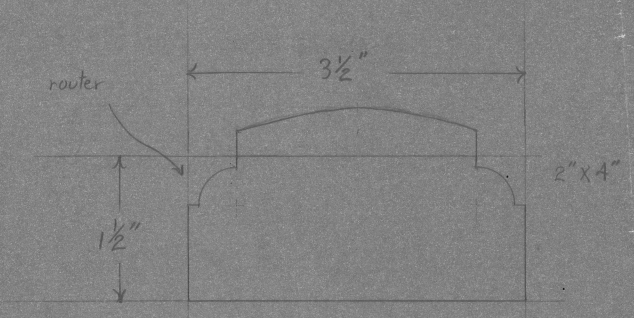

OAK ISLAND
STAIR RAIL SCALE: = 1" = 0"
SFB

#2

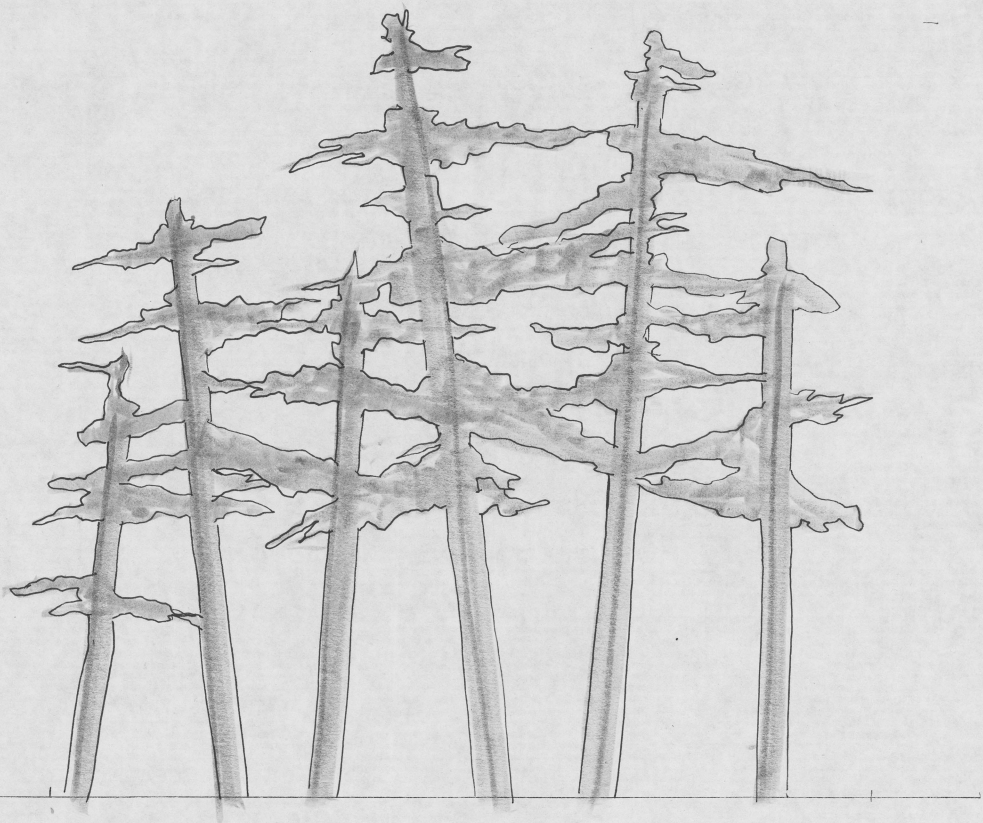

#1

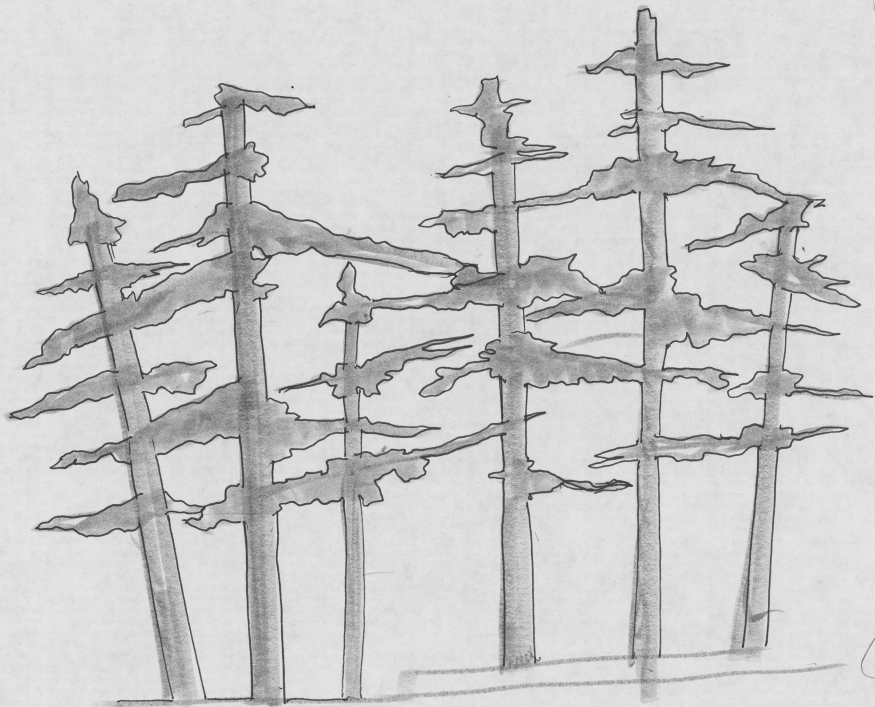

(SJD)

DROP #2

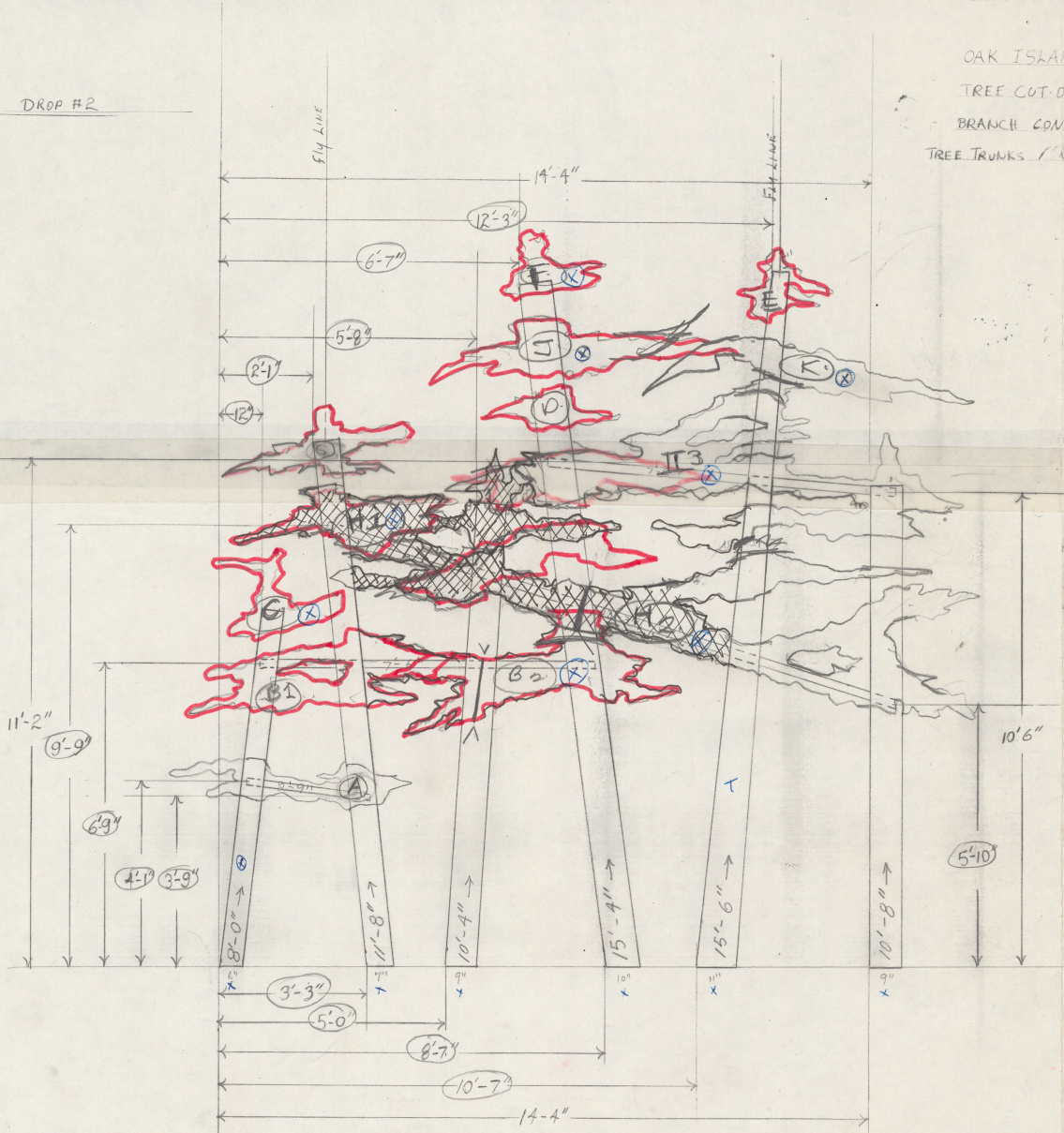

OAK ISLAND TREASURE

TREE CUT-OUTS SCALE 1/2" = 1'0"

BRANCH CONST. & SKIN PLY CUT OUT

TREE TRUNKS 1 1/2" RIFED 551 NOV 29/04

DROP #1

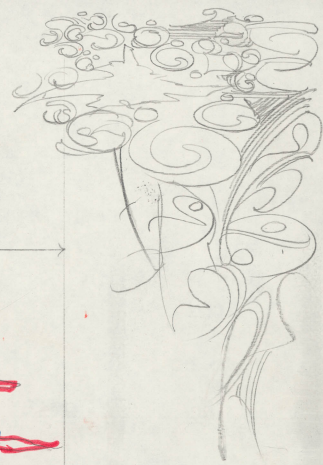
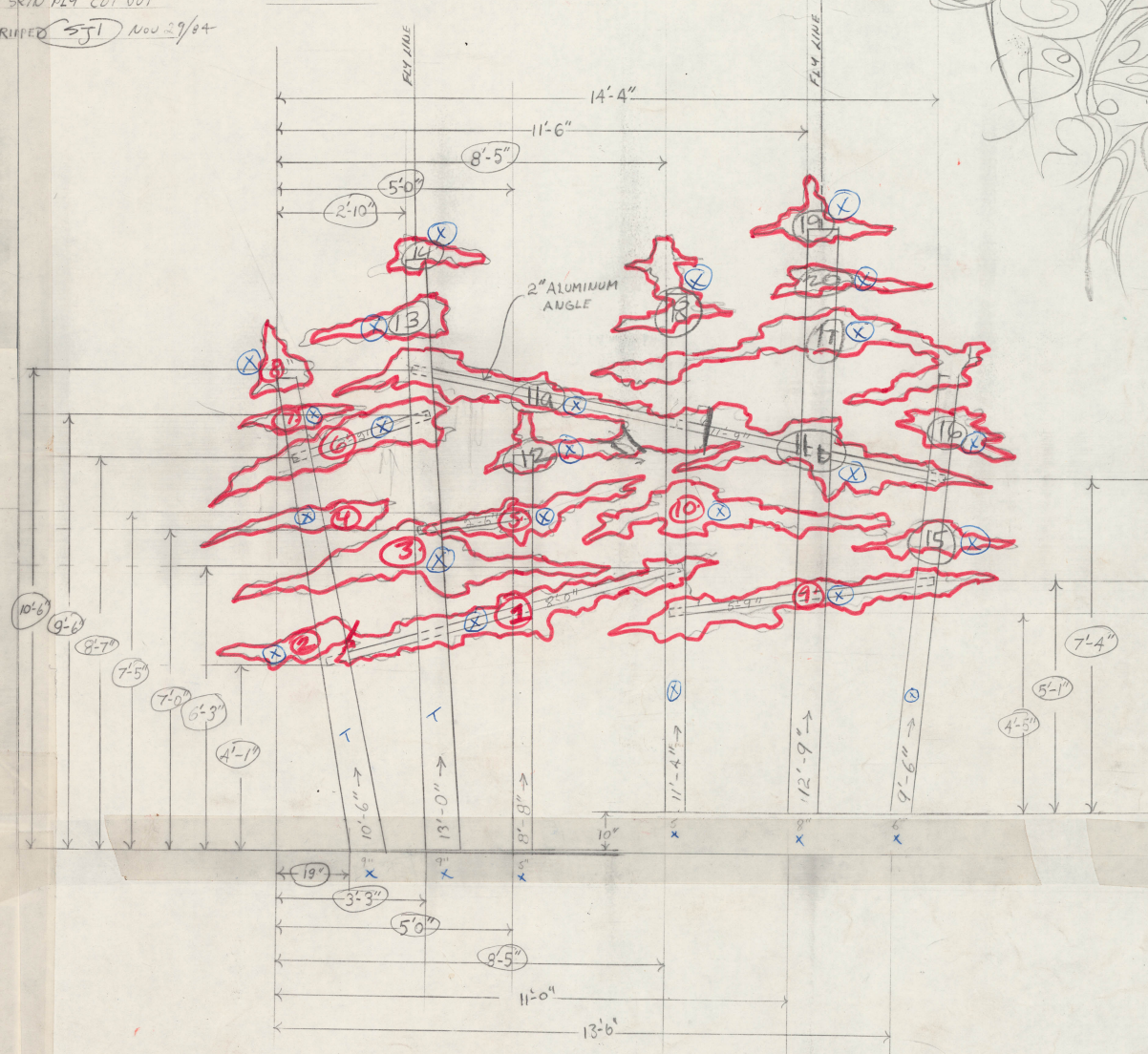

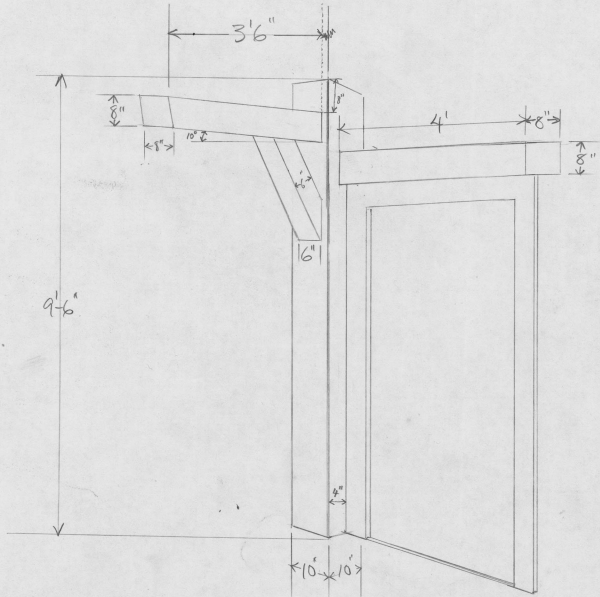

DOOR AND BEAMS

SCALE $\frac{1}{2}'' = 1'-0''$

ANDREW MURRAY

24
25

29

ACT II

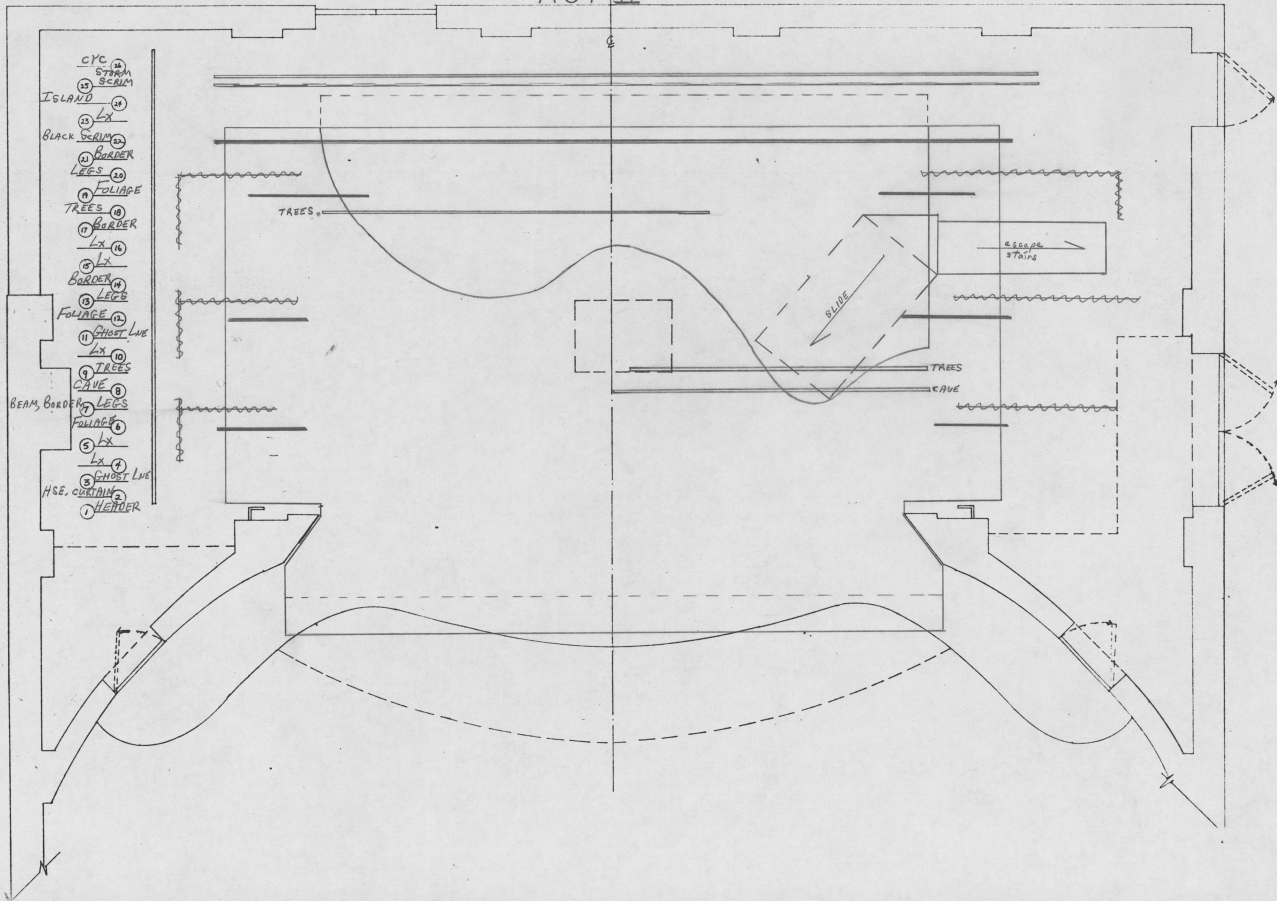

OAK ISLAND - ESCAPE STAIR LANDING

SCALE: $\frac{1}{2}'' = 1'$

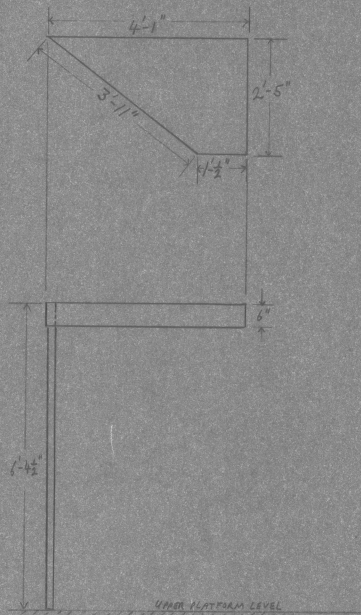

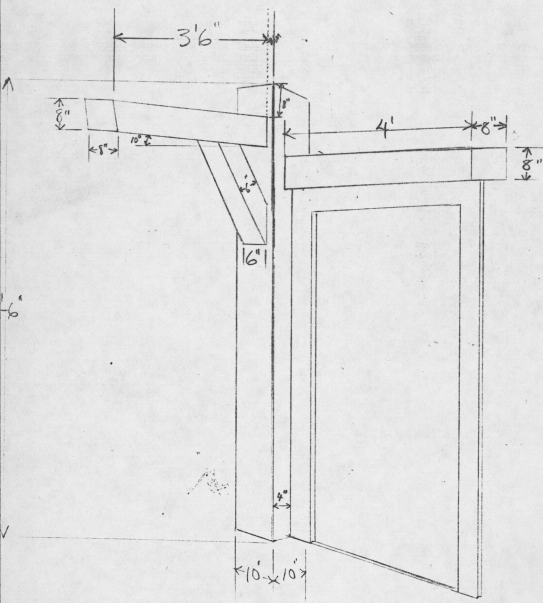

DOOR AND BEAM
 SCALE $\frac{1}{2}'' = 1'$
 ANDREW MURPHY

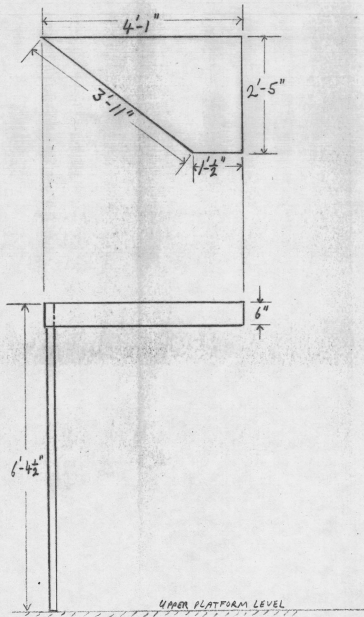

ACT I

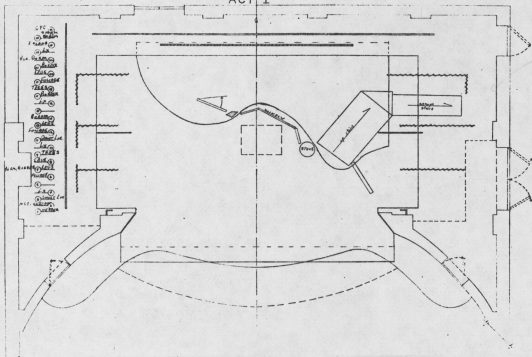

ACT I

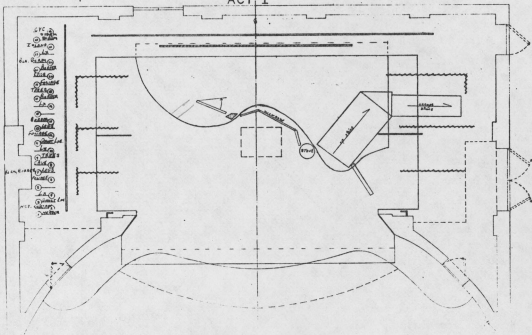

ACT I

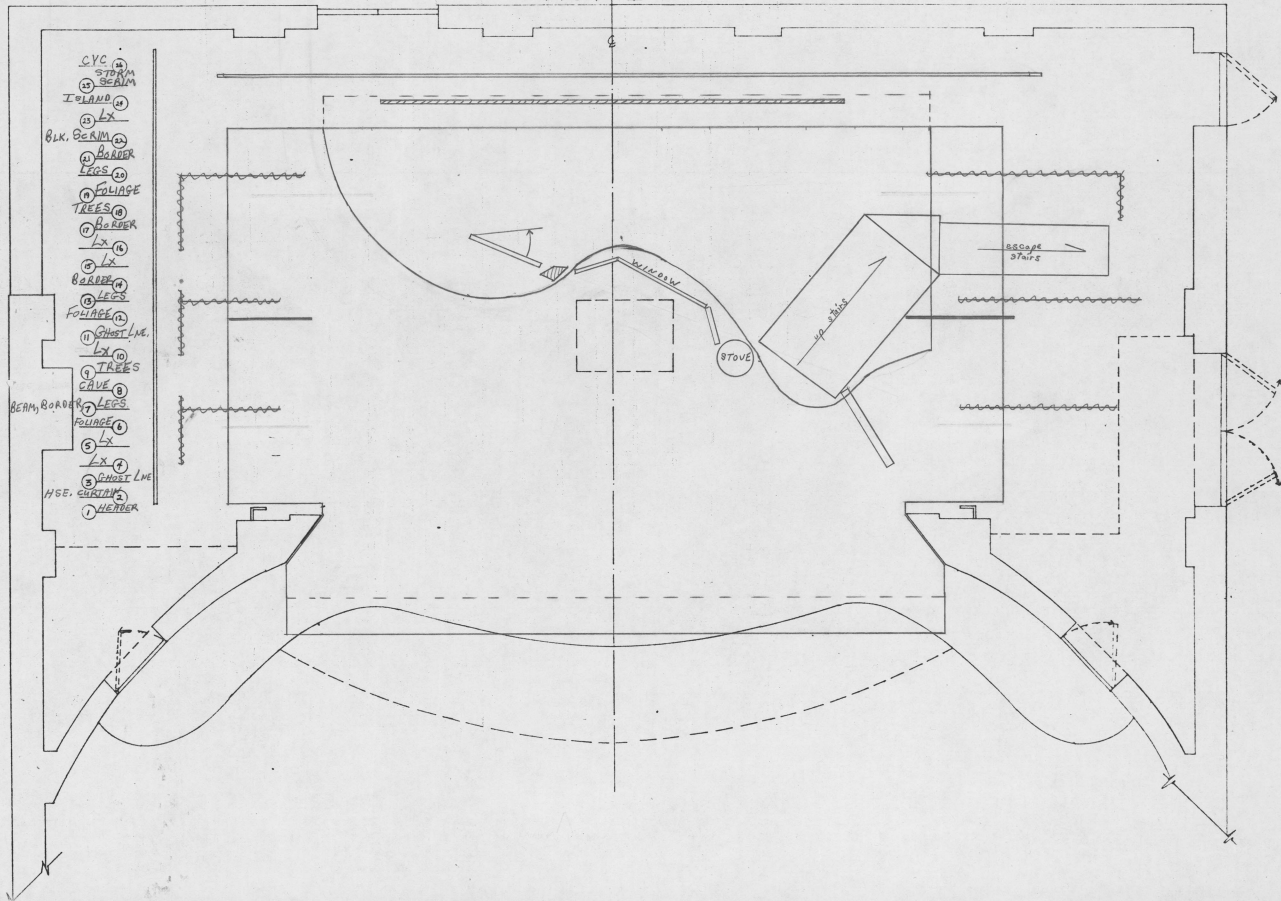

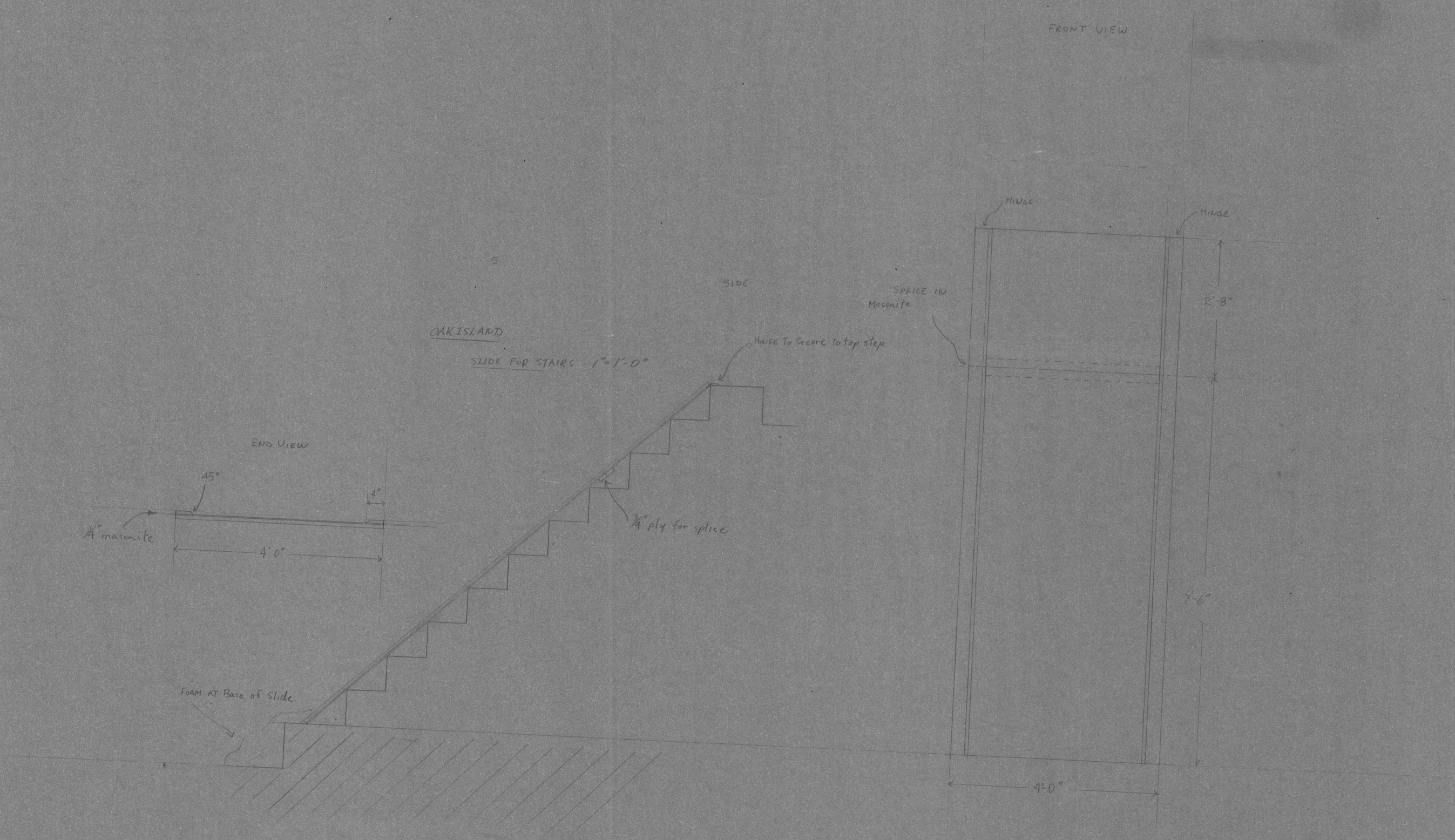

OAK ISLAND TREASURE
ACT I

GROUND PLAN
NEPTUNE THEATRE

SCALE: $\frac{1}{2}'' = 1'$

HANGING PLOT

- 26 CYCLOPAMA
- 25 STORM SCRAM
- 24 ISLAND CUT-OUT
- 23 No. 4 ELECTRIC (CYC)
- 22 BLACK SCRAM
- 21 4' BORDER
- 20 No. 3 LEGS
- 19 No. 3 FOLIAGE
- 18 TREE CUT-OUT
- 17 4' BORDER
- 16 No. 3 ELECTRIC
- 15 No. 2A ELEX (STRIPS)
- 14 8' BORDER
- 13 No. 2 LEGS
- 12 No. 2 FOLIAGE
- 11 GHOST LINE - TRAP DOOR
- 10 No. 2 ELECTRIC
- 9 TREE - CUT-OUT
- 8 CAVE DROP
- 7 No. 1 LEGS + BORDER + BEAM SUPPORT
- 6 No. 1 FOLIAGE
- 5 No. 1A ELEX (STRIPS)
- 4 No. 1 ELECTRIC
- 3 GHOST LINE - TRAP CHEST
- 2 HOUSE CURTAIN
- 1 FIRE CURTAIN

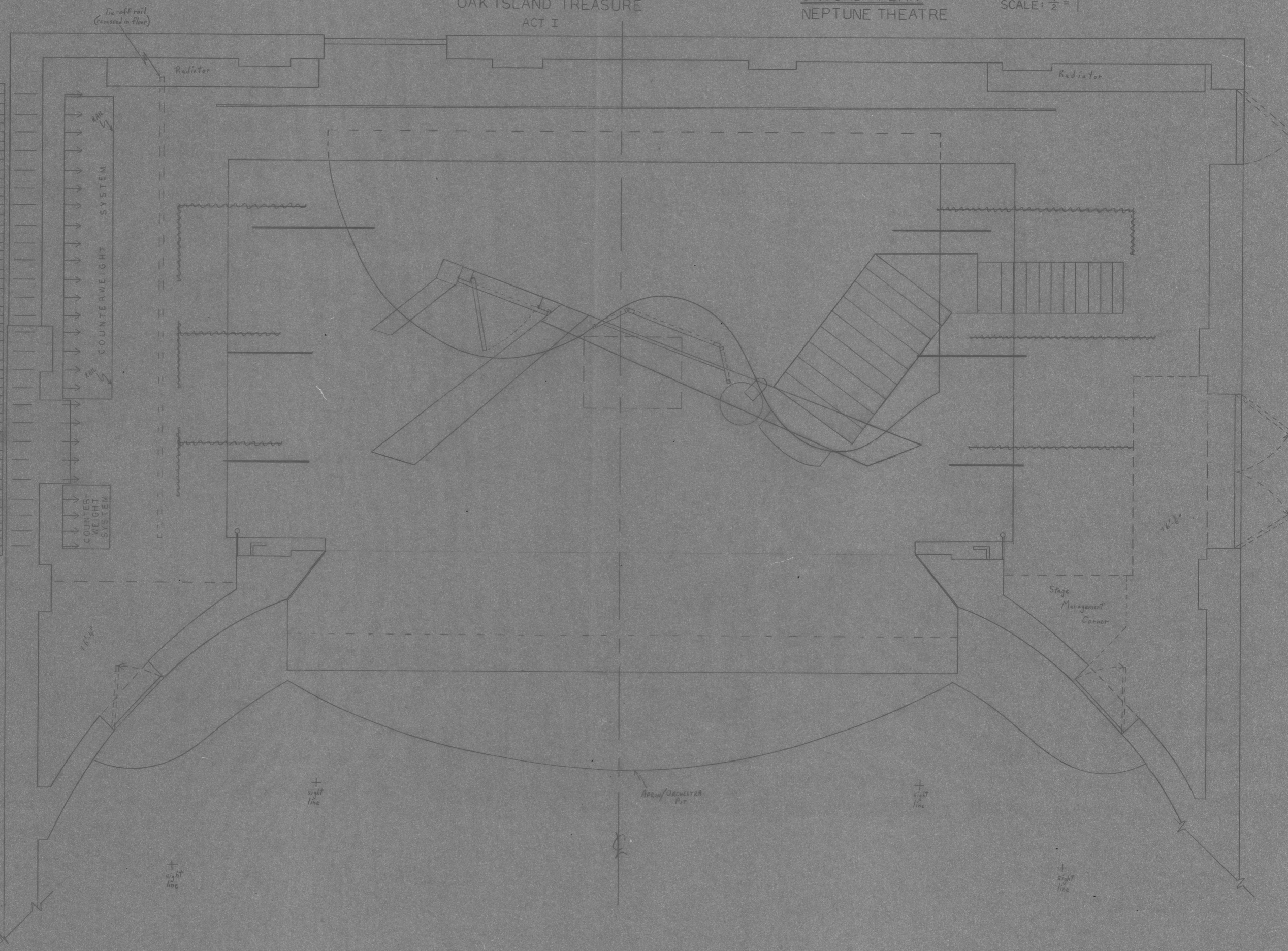

DROP #2

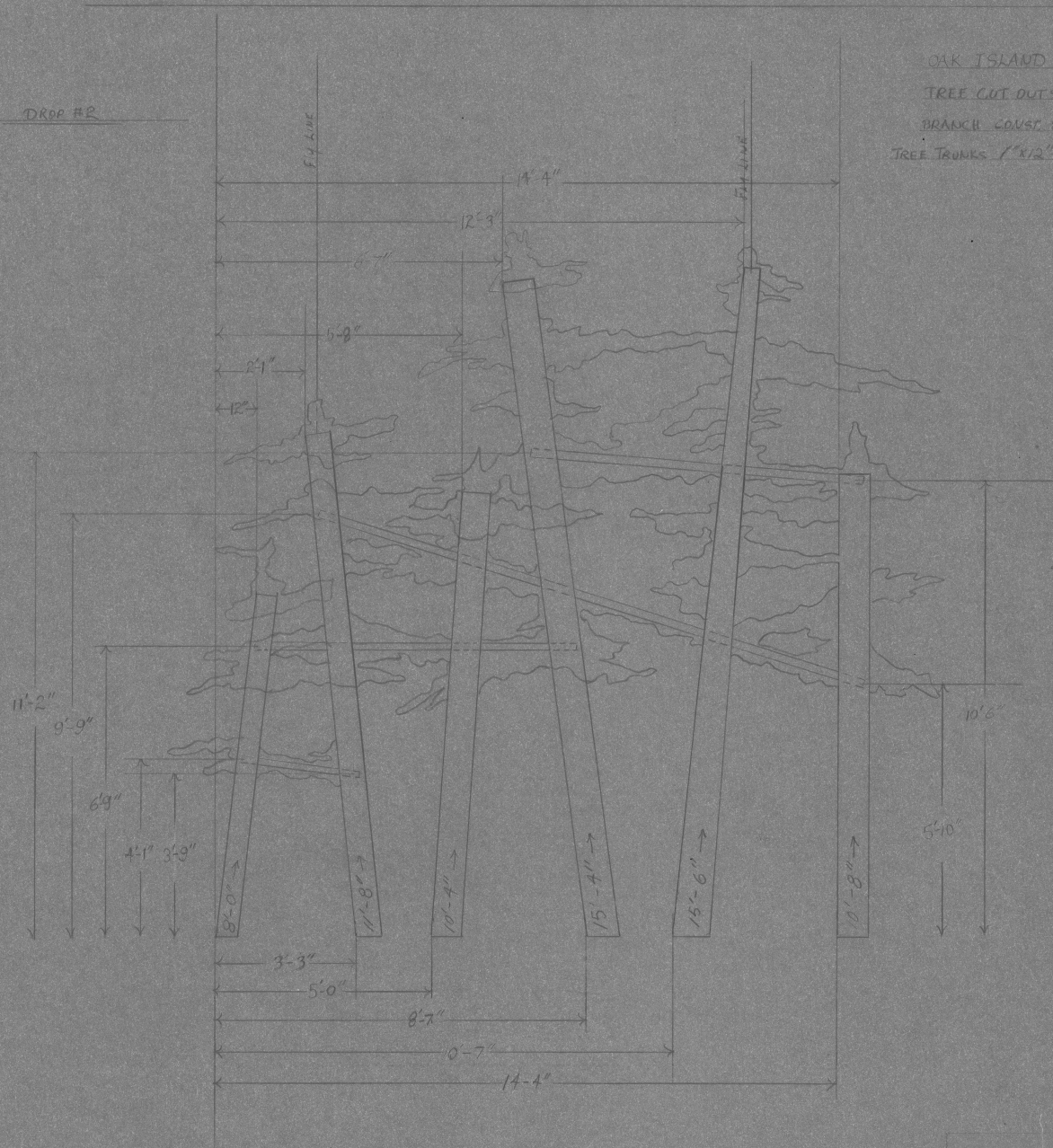

OAK ISLAND TREASURE
 TREE CUT OUTS SCALE 1/8"=1'-0"
 BRANCH CONST. : SKIN PLY CUT OUT
 TREE TRUNKS 1"X1/2" RIPPED (5) NOV 29/84

DROP #1

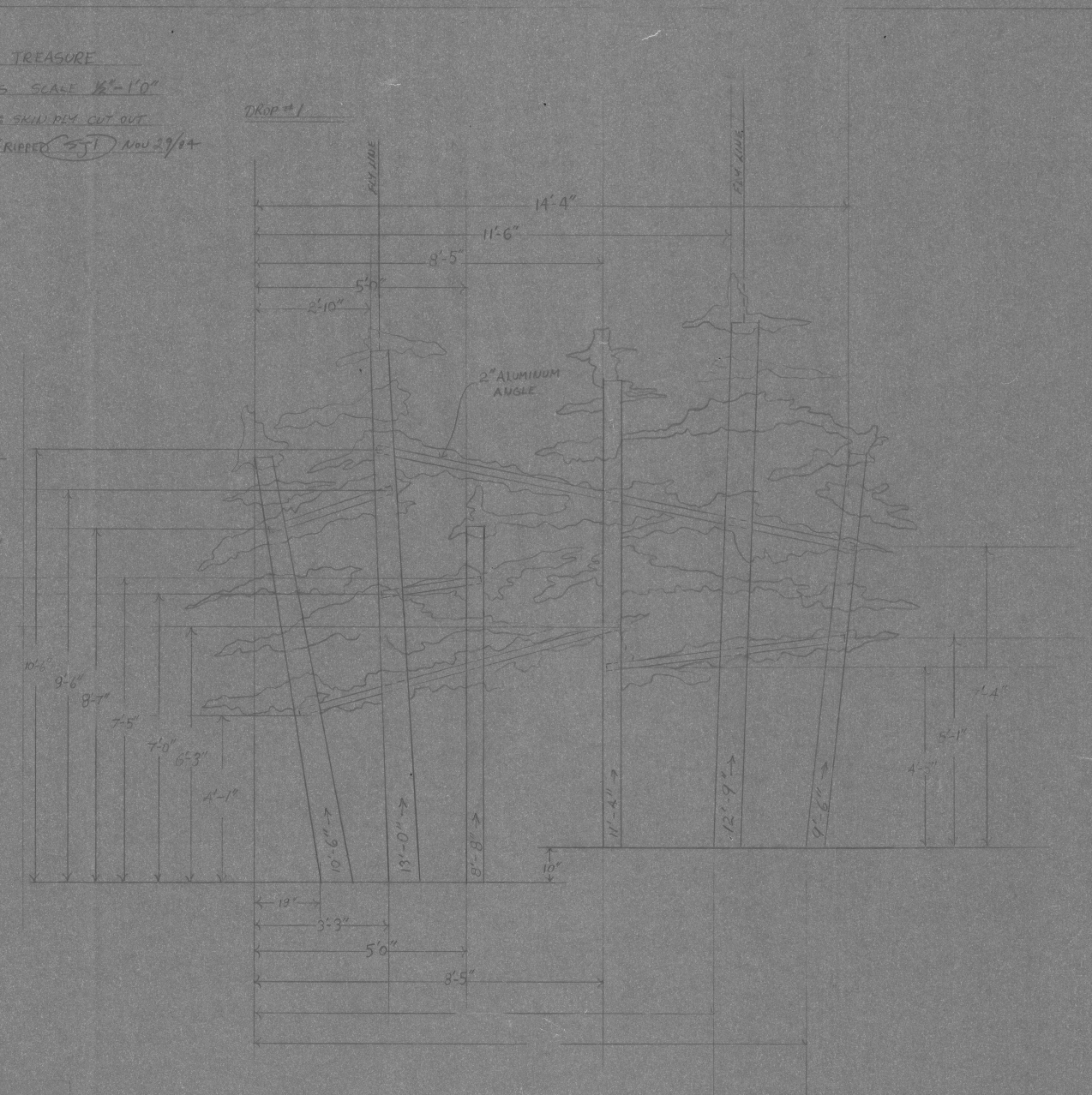

2" ALUMINUM ANGLE

GROUND PLAN
NEPTUNE THEATRE

SCALE: 1/2" = 1'

REVISED: SEPT. 1983
David B. Stogdolen

Tie-off rail
(recessed in floor)

Radiator

Radiator

Revised Hall
Rear Wall

Box U-01
376"

Stage
Management
Corner

APRON/ORCHESTRA
PIT

HANGING PLOT

26	CYC
25	CYC STORM SCRM
24	CUT OUT (ISLAND)
23	CYC STRIP SLITES
22	BLACK SCRM
21	BLACK LEG
20	FOilage NO. 3
19	
18	
17	TREE CUT OUT NO. 2
16	
15	BLACK LEG
14	FOilage NO. 2
13	BEAM LINE ?
12	
11	GHOST LINE
10	TREE CUT OUT NO. 1
9	CAVE CUT OUT
8	
7	BEAM LINES
6	BLACK LEG
5	FOilage NO. 1
4	ISI ELEX
3	
2	HOUSE CURTAIN
1	FIRE CURTAIN

COUNTERWEIGHT SYSTEM

COUNTERWEIGHT SYSTEM

x 6' x 4"

x 6' x 6"

sight line

sight line

sight line

sight line

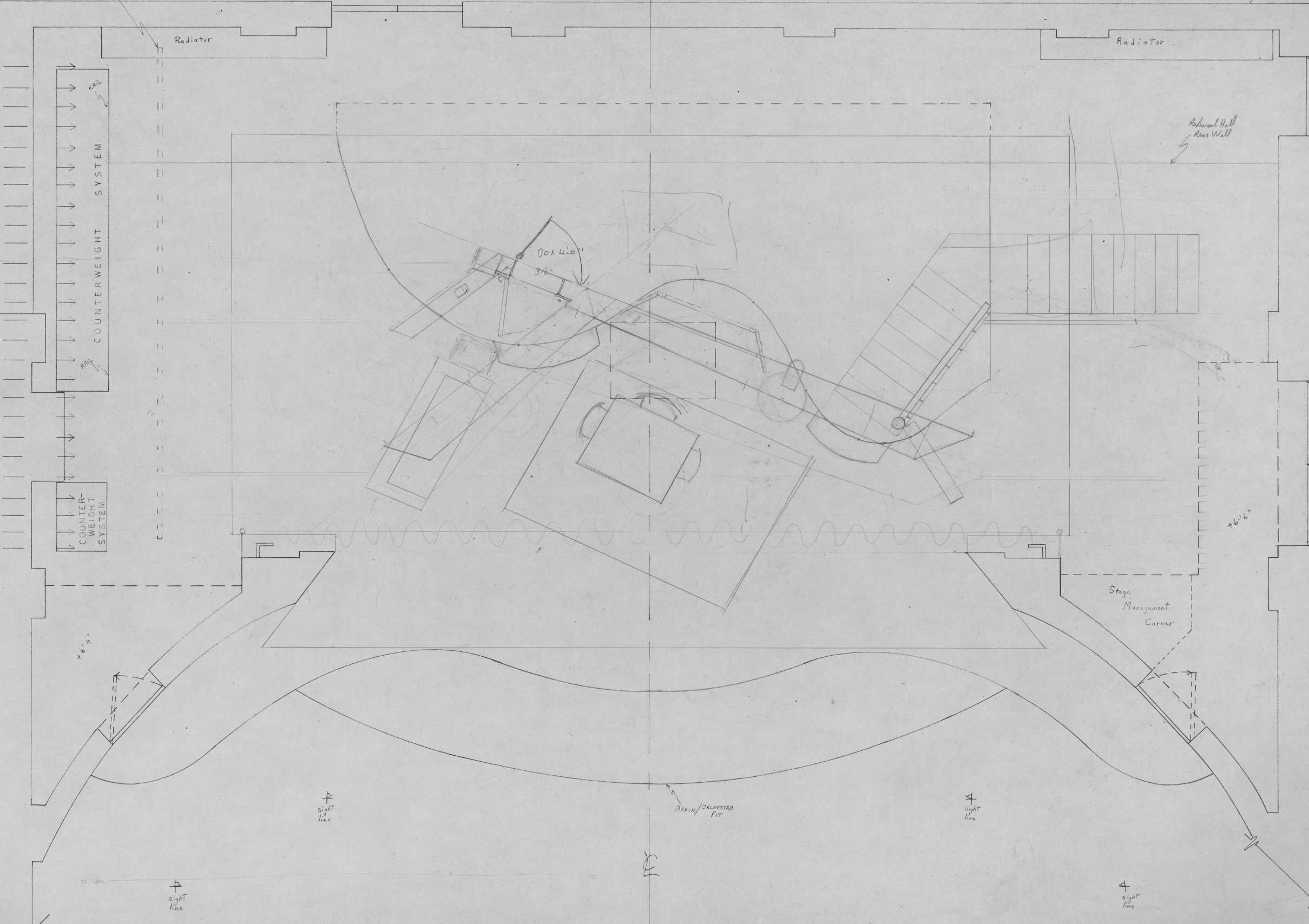

GROUND PLAN
NEPTUNE THEATRE

SCALE: 1/2" = 1'

REVISED: SEPT. 1983
David B. Robinson

- HANGING PLOT
- 26
 - 25
 - 24
 - 23
 - 22
 - 21
 - 20
 - 19
 - 18
 - 17
 - 16
 - 15
 - 14
 - 13
 - 12
 - 11
 - 10
 - 9
 - 8
 - 7
 - 6
 - 5
 - 4
 - 3
 - 2 HOUSE CURTAIN
 - 1 FIRE CURTAIN

Tie-off rail
(recessed in floor)

Radiator

Radiator

RAIL

COUNTERWEIGHT SYSTEM

RAIL

COUNTERWEIGHT SYSTEM

Stage Management Corner

x 6' 6"

x 6' 6"

sight line

APRON / ORCHESTRA PIT

sight line

sight line

sight line

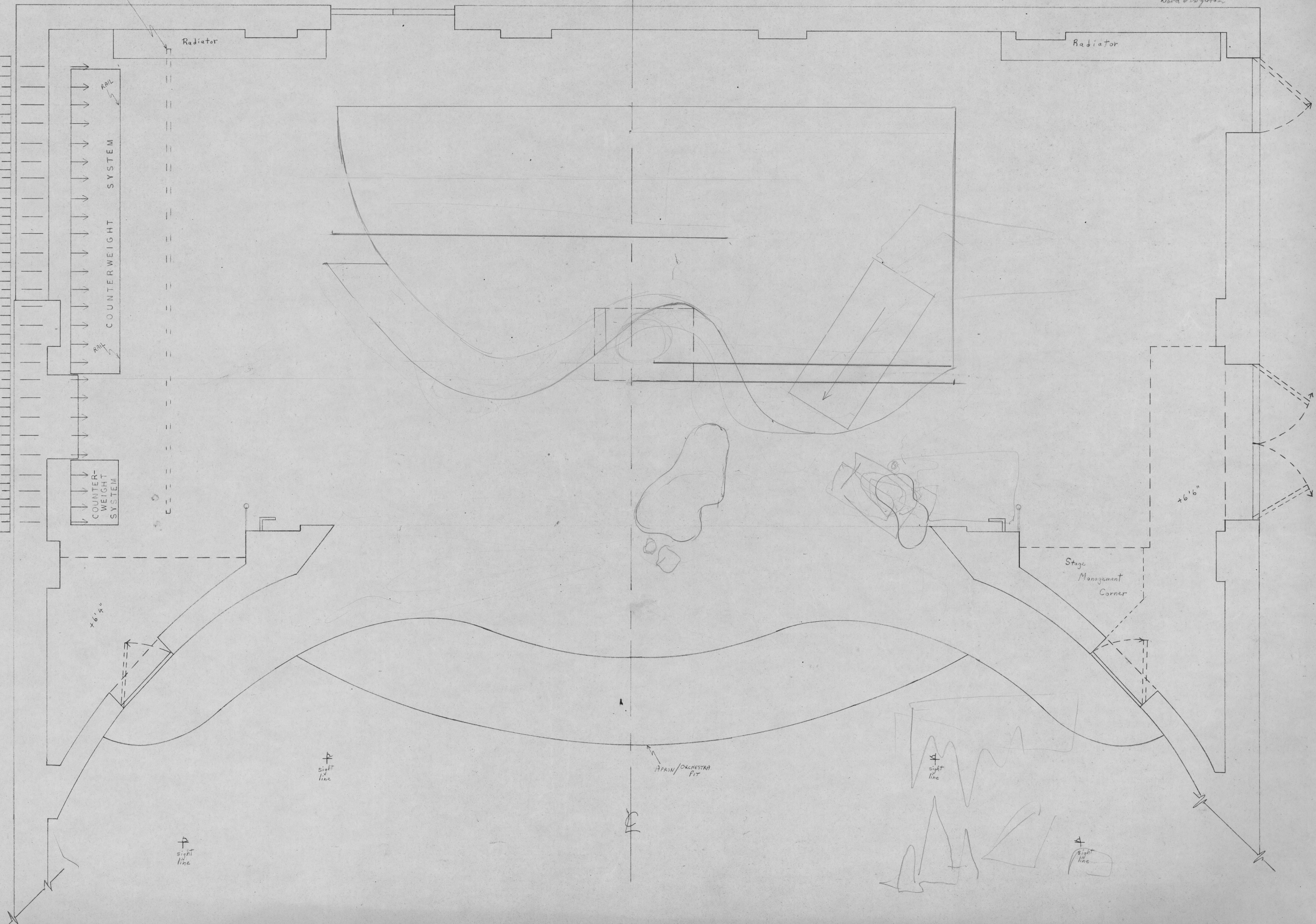

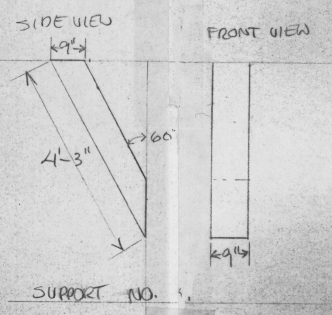
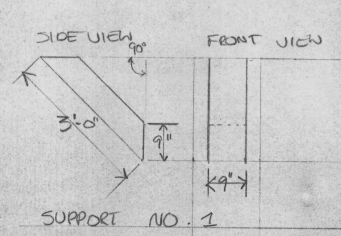
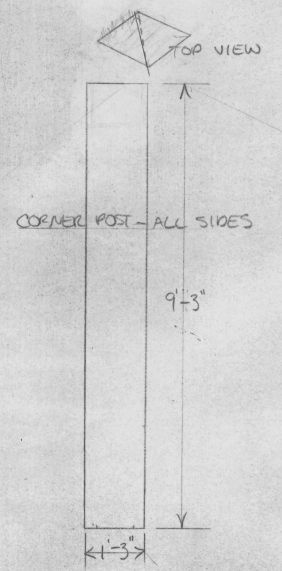
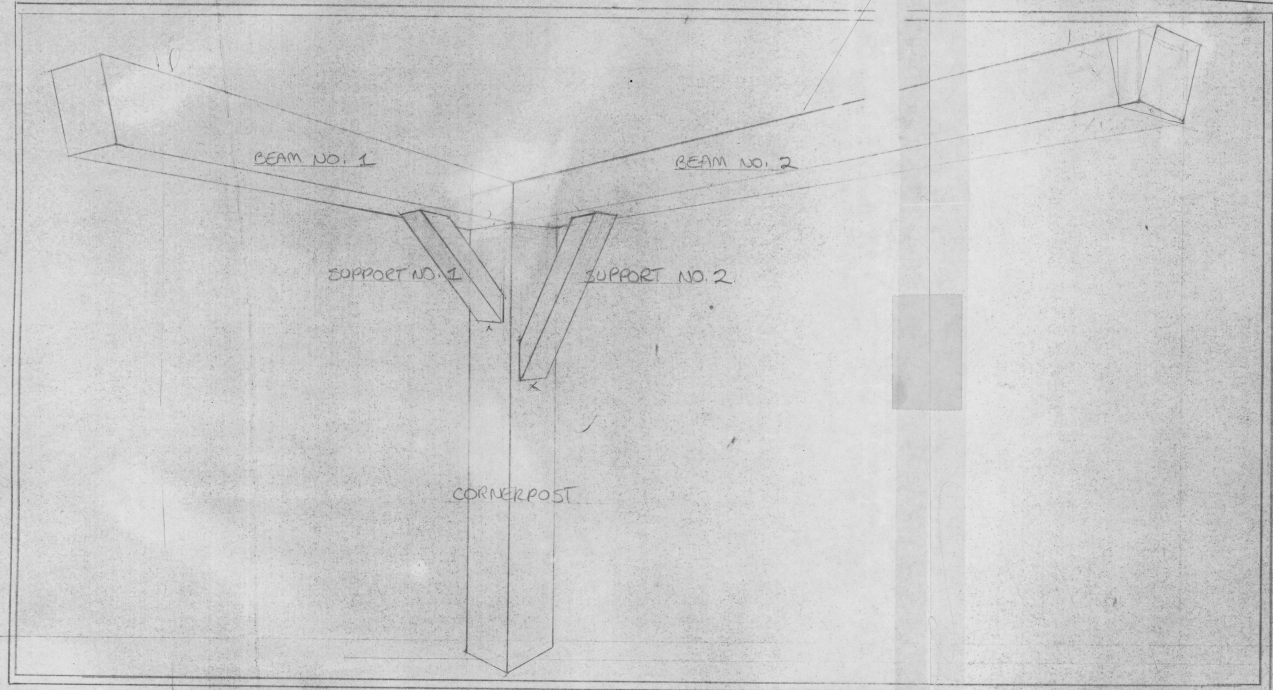
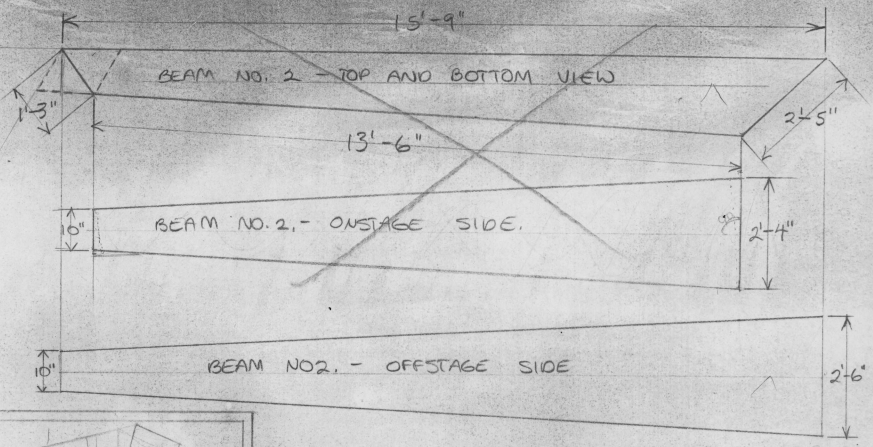
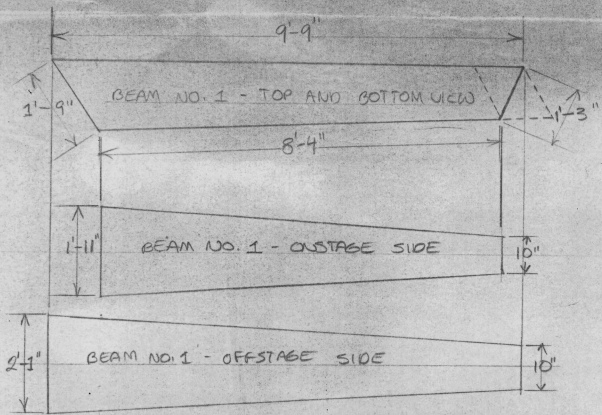

BEAM DRAWING
 THE MYSTERY OF THE OAK ISLAND TREAS
 DIRECTOR - BOB PAISLY
 DESIGNER - ANDREW MURRAY / SI DAGINE
 NOV. 11, 1984
 SCALE $\frac{1}{2}'' = 1'-0''$

FULL SCALE HAND RAIL

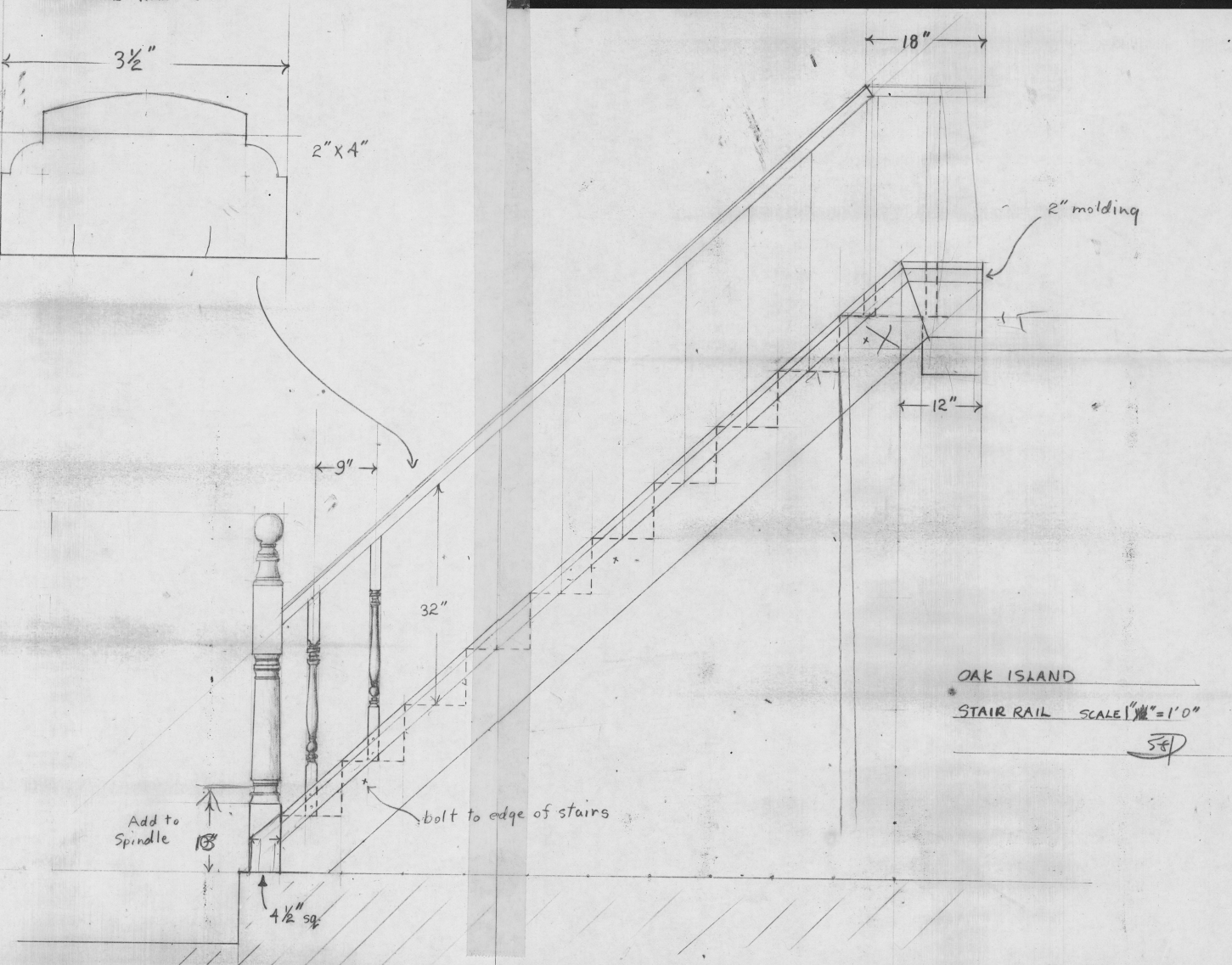
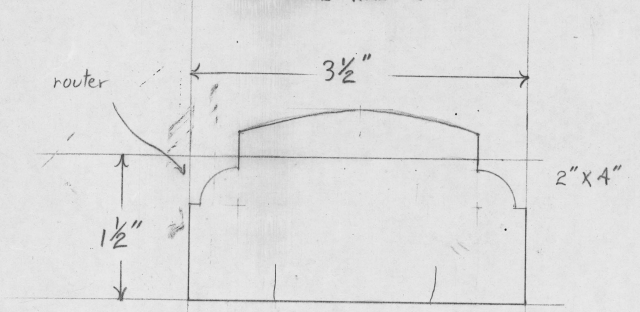

OAK ISLAND
STAIR RAIL SCALE $\frac{1}{8}" = 1'0"$

SEP

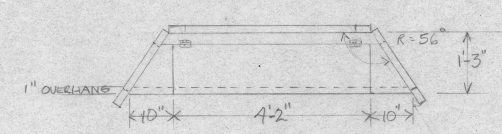
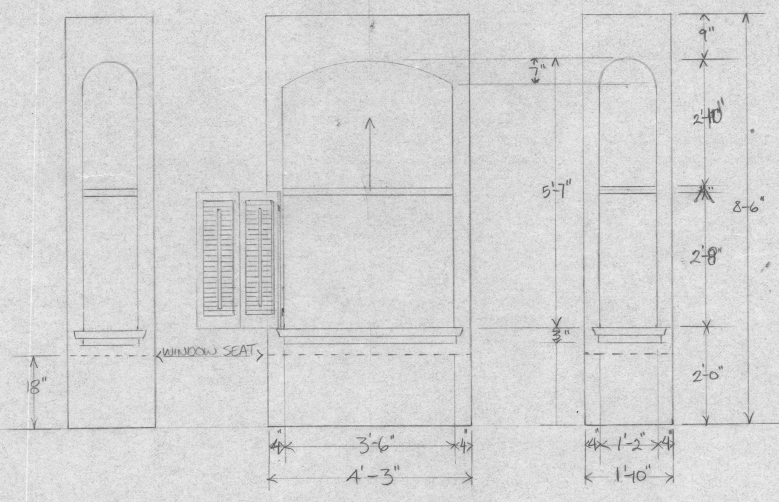
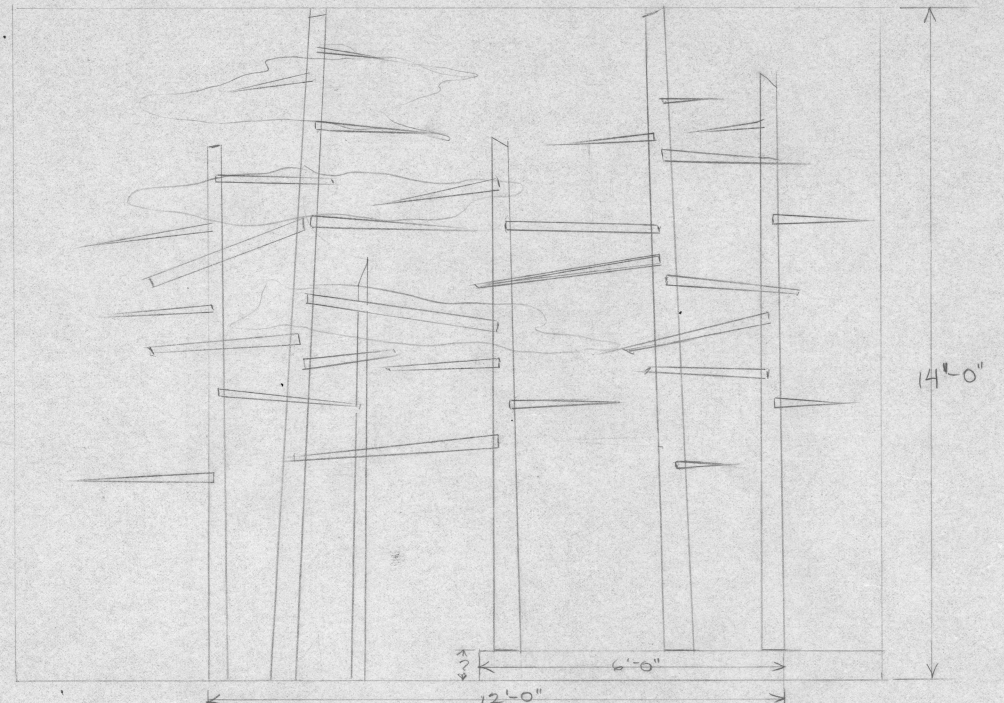
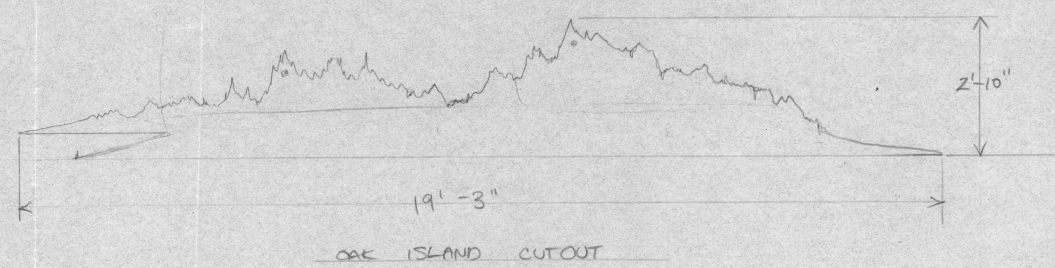

FLATS - OAK ISLAND
 DIRECTOR - BOB PAISLEY
 DESIGNERS - A. MURRAY / S. DEGAUSTIN
 NOV. 11, 1984
 SCALE - 1/2" = 1'-0"

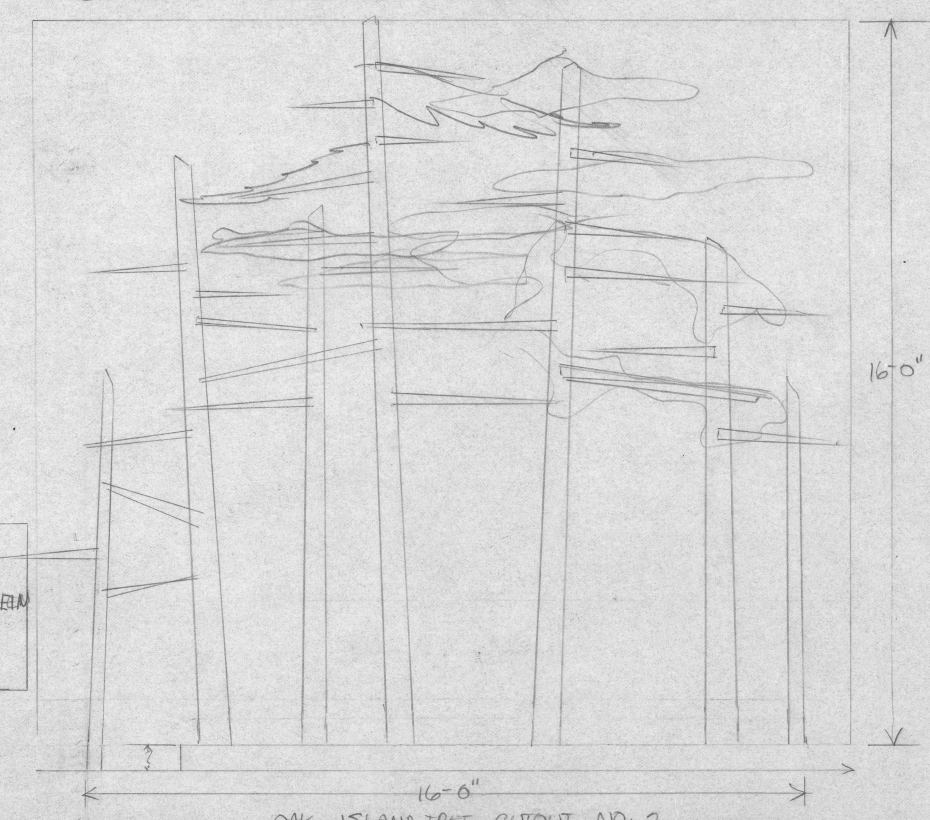

OAK ISLAND TREASURE

GROUND PLAN
NEPTUNE THEATRE

SCALE: 1/2" = 1'

ACT I

HANGING PLOT

- 26 CYCLOPAMA
- 25 STORM SCRIM
- 24 ISLAND CUT-OUT
- 23 No. 4 ELECTRIC (STRIPS)
- 22 BLACK SCRIM
- 21 4' BORDER
- 20 No. 3 LEGS
- 19 No. 3 FOLIAGE
- 18 TREE CUT-OUT
- 17 4' BORDER
- 16 No. 3 ELECTRIC
- 15 No. 2A ELEX (STRIPS)
- 14 8' BORDER
- 13 No. 2 LEGS
- 12 No. 2 FOLIAGE
- 11 GHOST LINE - TRAP DOOR
- 10 No. 2 ELECTRIC
- 9 TREE - CUTOUT
- 8 CAVE DROP
- 7 No. 1 LEGS + 6' BORDER + BEAM SUPPORT
- 6 No. 1 FOLIAGE
- 5 No. 1A ELEX (STRIPS)
- 4 No. 1 ELECTRIC
- 3 GHOST LINE - TREASURE CHEST
- 2 HOUSE CURTAIN
- 1 FIRE CURTAIN + HEADER

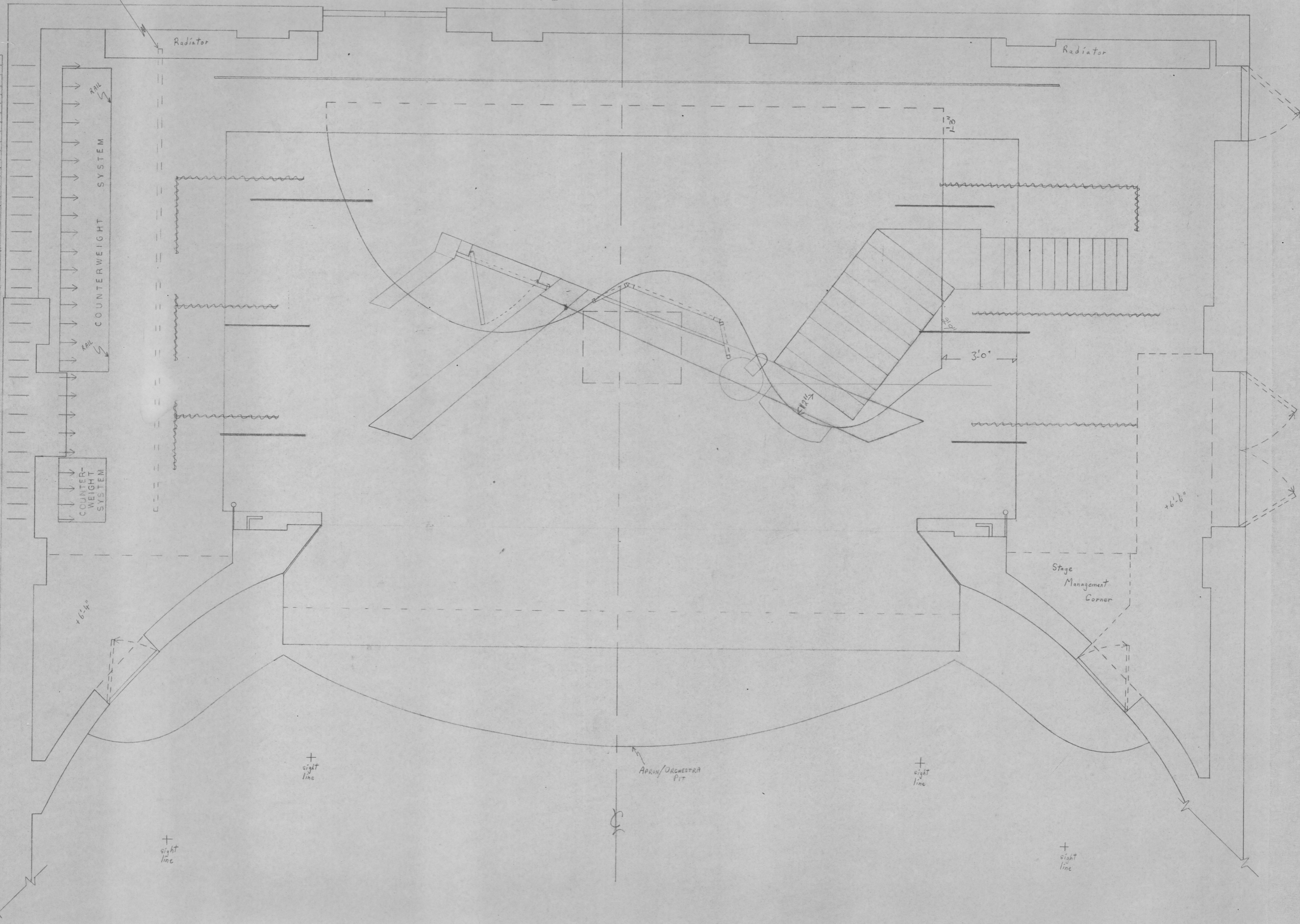

+ sight line

+ sight line

APRON/ORCHESTRA PIT

+ sight line

+ sight line

+6'4"

+6'6"

3'0"

1'3"

SPARK

Tie-off rail (recessed in floor)

Radiator

Radiator

COUNTERWEIGHT SYSTEM

COUNTERWEIGHT SYSTEM

Stage Management Corner

OAK ISLAND

SLIDE FOR STAIRS 1" = 1'-0"

END VIEW

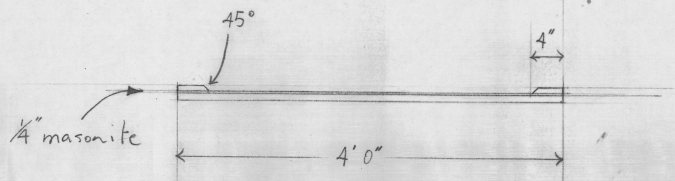

FOAM AT Base of Slide

3/4" ply for splice

HINGE To Secure to top step

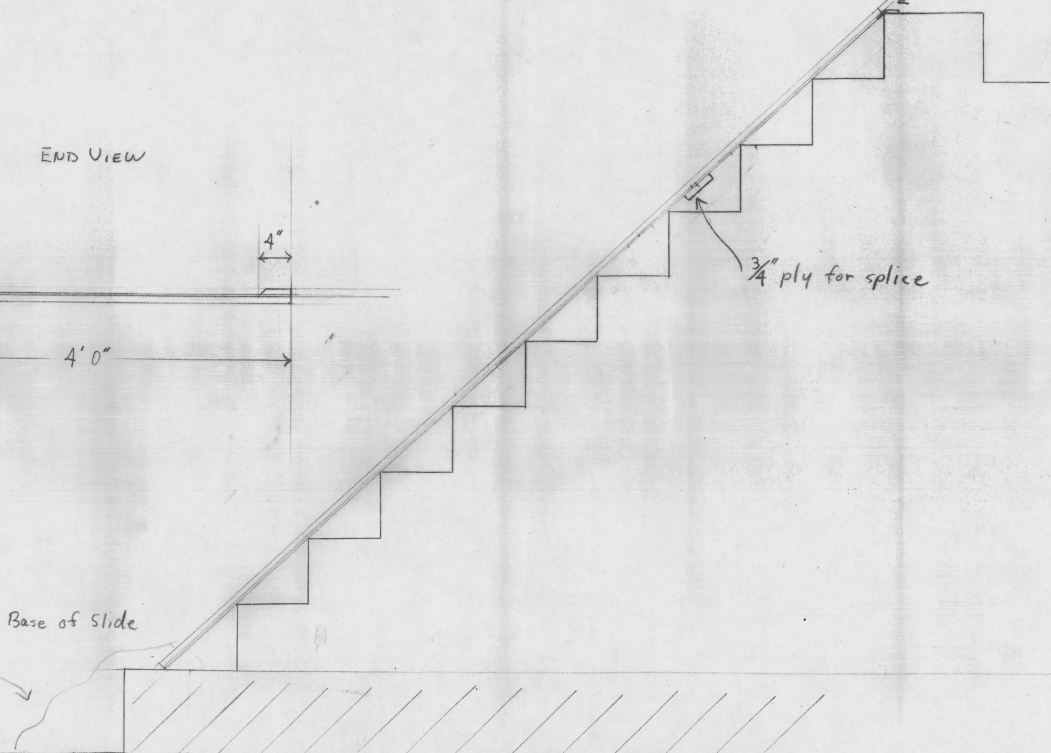

FRONT VIEW

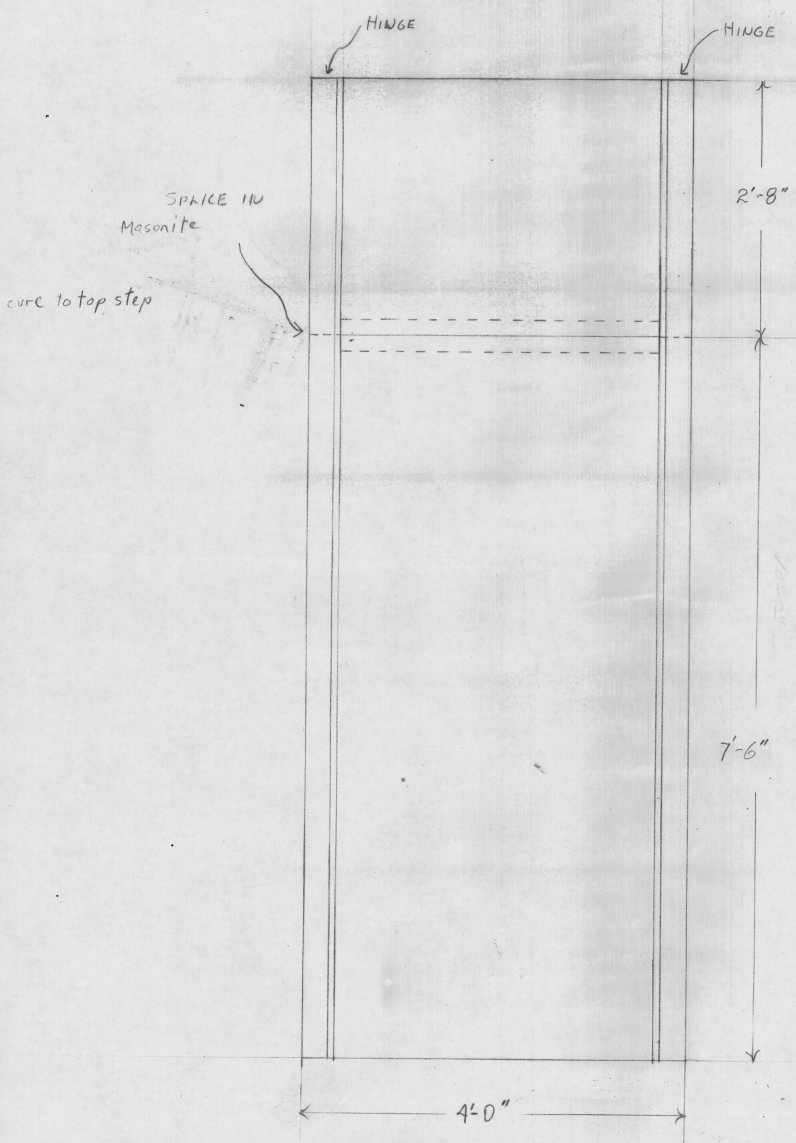

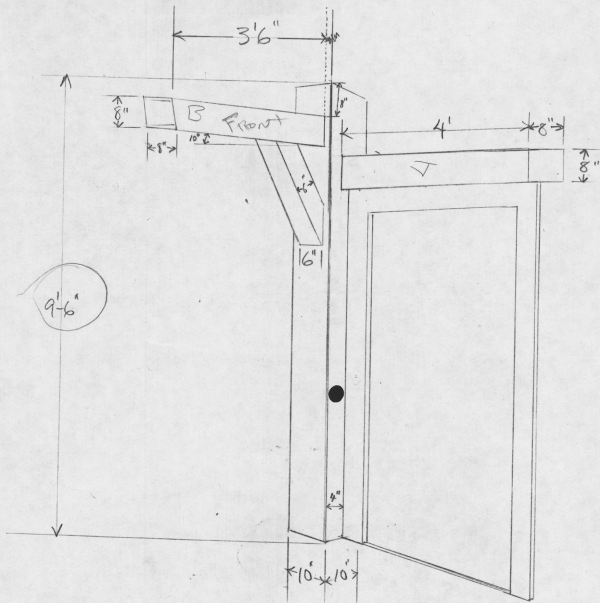

DOOR AND BE
 SCALE $\frac{1}{2}'' = 1'$
 ANDREW MUR

Post $7'-4\frac{1}{4}"$

9 Risers $8\frac{7}{16}"$

1 " 7"
10 " $6\frac{5}{8}"$

~~5'-7"~~

OAK ISLAND - ESCAPE STAIR LANDING

SCALE: $\frac{1}{2}" = 1'$

$11\frac{1}{8}"$

